

CARE & MAINTENANCE >>

1. To clean the Habitat, remove the fabric from the frame, and hand wash, DO NOT machine wash.
2. Hang the fabric up and let air dry, keeping it out of direct sunlight.
3. Do not store the Habitat wet.
4. Do not use bleach on the Habitat.
5. It may be unsafe to use accessories other than those approved by guzzie+Guss
6. It may be unsafe to use replacement parts other than those supplied or approved by guzzie+Guss
7. if you have any questions regarding the product please contact guzzie+Guss at 1-888-597-0992, or online at www.guzzieandguss.com. We will provide you the best customer service.

PRODUCT REGISTRATION AND WARRANTY >>

The Habitat has a Limited Warranty for the period of 1 year from the date of purchase against manufacture's defects and workmanship.

For Registration: submit online @ www.guzzieandguss.com
Or mail to the address provided.

Imported by:
Peter John M. Distributions
#114 - 6951 - 72 street Delta, BC
Canada V4G 0A2

info@guzzieandguss.com
Tel 1-888-597-0992
Fax 1-604-940-4462

HABITAT
Instruction Manual

guzzie+Guss®

Habitat

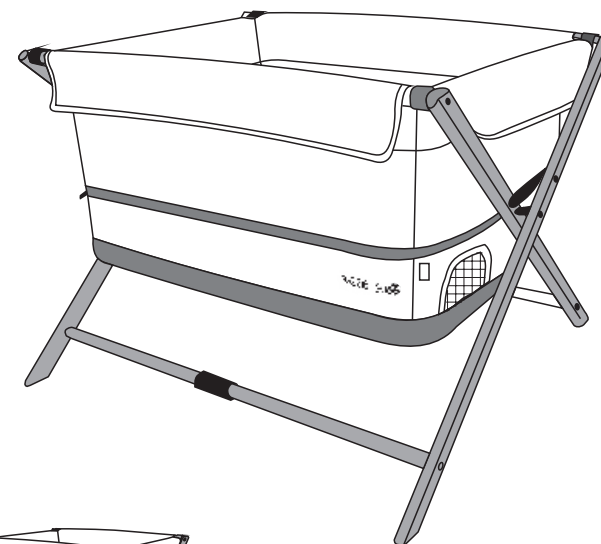

Please read this instruction manual carefully before using this product.
Be sure to save these instructions for future reference.

INTRODUCTION >>

guzzie+Guss are committed to making the lives of children and parents safe, uncomplicated and convenient. We would like to thank you for purchasing this exciting product. It is important that you read and follow the instructions in this manual carefully. Please make sure all the parts are properly attached and the removable pieces fit on correctly. Please pay close attention to the opening and closing mechanism. Read all warnings and safety steps before use.

IMPORTANT >>

After completely reading and following all instructions in this manual, please file the instruction manual in a safe place for future reference. If the product you have received operates differently from instructions included with the product please contact guzzie+Guss at info@guzzieandguss.com. There you can obtain the most current information regarding your new Habitat

INCLUDED PARTS >>

- 1) Frame
- 2) Carry bag
- 3) Mattress
- 4) Mesh Bug Net
- 5) Fabric
- 6) Instructions



ASSEMBLY INSTRUCTIONS >>

First remove the Habitat from the zippered carry bag.

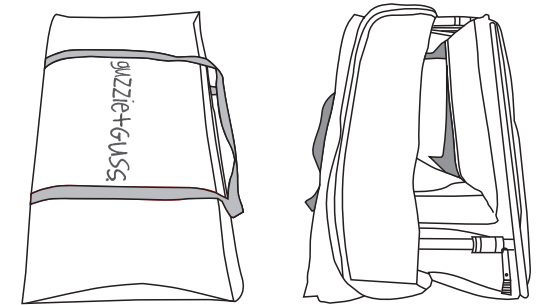

Open the frame up and push the frame locks down into place.

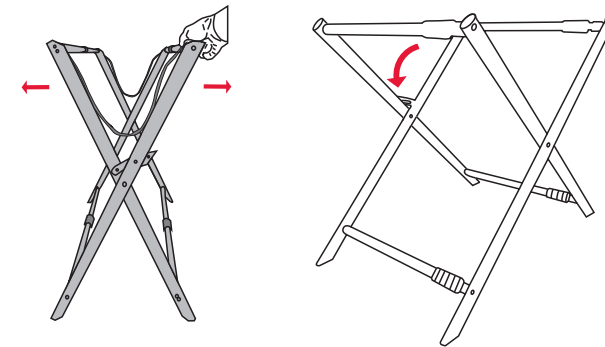

Now, to stretch the frame length wise, turn the Habitat on its side and lift until the frame clicks into place, making sure that all 4 rails are properly locked in the open position (you should hear a click).

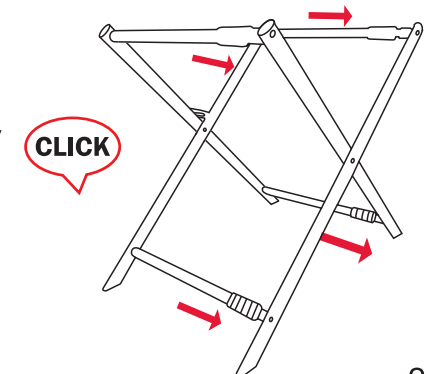

You can do this by grabbing the rails on both sides of the center, and seeing if the rails will extend any farther.

ASSEMBLY INSTRUCTIONS >>

Place the fabric on the inside of the frame, making sure to place the short side on the end.

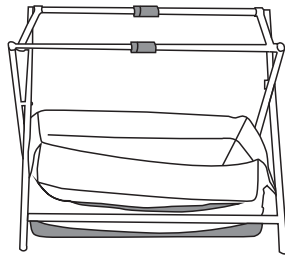

Place the long side fabric flap over the frame; locate the zipper on the underside of the flap, and attach to the corresponding zipper on the side of the fabric. Repeat on the other 3 sides.

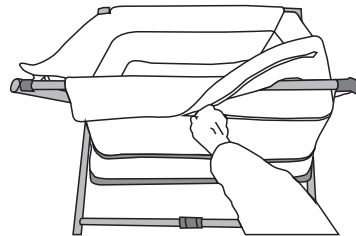

The bassinette should be at the top level please make sure that the zippers are completely zipped up before placing the mattress in.

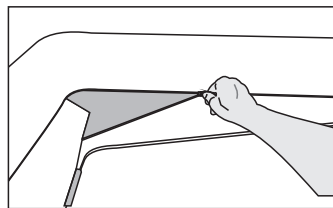

Place the mattress pad into the bassinette. Make sure the mattress is placed with the hard side down, and make sure it is firmly against the bottom of the bassinette floor.

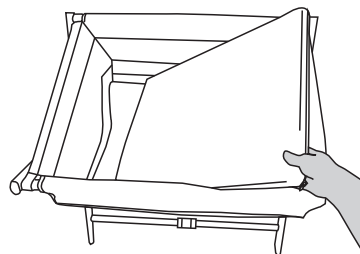

WARNING: Do not adjust the levels of the Habitat with your child inside

OPERATIONS INSTRUCTIONS >>

To lower the mattress level, you will find on the inside and the outside of, unit a zipper that goes around the entire circumference of the Habitat.

You need to unzip both the inner and the outer zippers, and the level should drop to the floor.

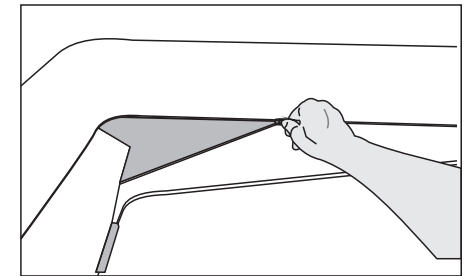

WARNING: Please do not adjust the levels of the Habitat with your child inside

WARNING: Please do not move the Habitat with your child inside
WARNING: DO NOT Use the Habitat with only 1 Zipper being engaged

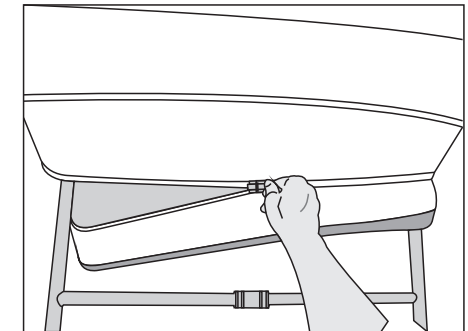

Bassinette

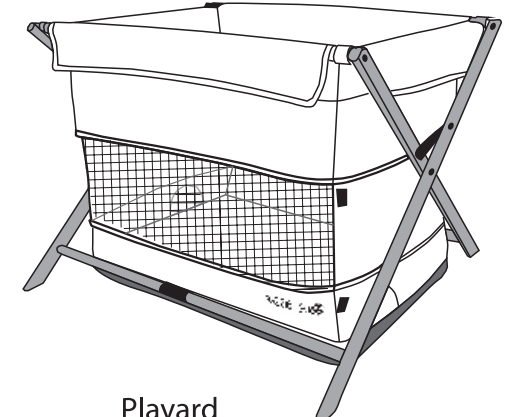

Playard

OPERATIONS INSTRUCTIONS >>

Using the Bug Netting

The bug netting has elastic corners, place each corner over a corresponding corner, and stretch out the netting over the 4 corners.

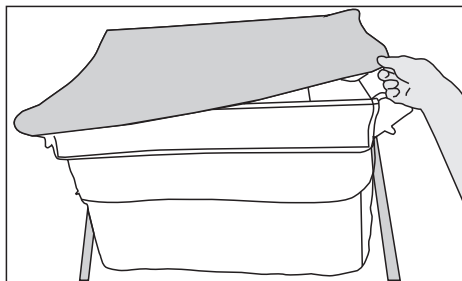

The Zipper pull should be tucked up into the fabric when you are using the bassinette feature.

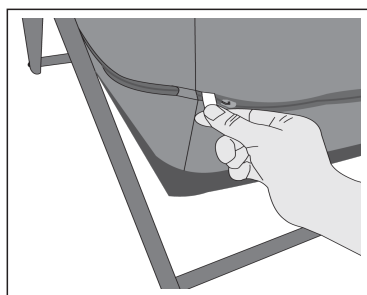
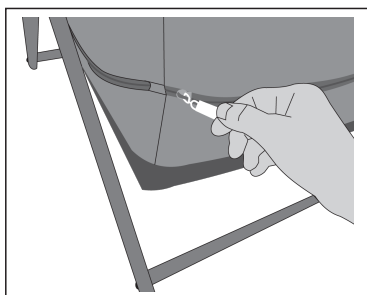

Storing the Habitat

Warning: Please remove your child prior to attempting to collapse the Habitat

First remove the mattress. To fold the frame, find in the middle of the 2 upper sliding rails there is a lever, you need to release these. You will find on the 2 lower sliding rails the same levers, please release these as well.

Now release the safety at the center of the X on the end of the legs.

You can now slide the frame down, and scissor the frame together. You can then pack the folded frame into the carry bag along with the mattress and the bug net.

Limited Warranty >>

Your guzzie+Guss unit is warranted to be free from any manufacturing defects for a period of 1 year from the date of purchase under normal use and when used in compliance with the operating instructions. The warranty is non-transferable and is only valid for the original owner. This warranty is only effective when supplied with valid proof of purchase from an authorized guzzie+Guss retailer, please retain proof of purchase for the warranty.

The warranty is only valid in the original country of purchase. This warranty is subject to the conditions set forth by country in which it was purchased, conditions may vary. Guzzie+Guss will not ship replacement or repair part out of the country of original purchase.

Guzzie+Guss will conduct repairs or send out replacement parts as determined by guzzie+Guss or an authorized repair departments working on behalf of guzzie+Guss. Guzzie+Guss reserve the right to exchange a part or the item with a replacement part or unit. Some parts may be replaced with newer model parts as the unit may be improved over time.

Please note a service issue MAY NOT ALWAYS be covered by the warranty if:

- The issue is caused by misuse or poor maintenance. Please refer to your instructions for guidance on stroller use and maintenance.
- Damage is caused by improper installation of guzzie+Guss parts and or accessories.
- Damage is caused by corrosion caused by lack of maintenance.
- Damage is caused by general wear and tear, which is caused by everyday use.
- Damage is caused by sun intensity, sweat, detergents, damp storage or frequent washings.
- Repairs or modifications are carried out by third party
- Item are purchased from an unauthorized dealer.
- Item was purchase second hand
- Item was damaged as a result of an accident, airline or freight claim.

Guzzie+Guss reserves the right to determine if warranty terms and conditions have been met

WARNINGS >>

Please note the following to ensure safe use of your Playpen/Bassinet

- Read and understand these instructions before using this product.
- Do not use this bassinet if you cannot exactly follow the accompanying instructions.
- To ensure proper use, store this user guide in a convenient place so it can be consulted often.
- Failure to follow all warnings and instructions could result in serious injury or death.
- SUFFOCATION HAZARD Infants can suffocate: On soft bedding, NEVER add a mattress, pillow, comforter, or padding. Use ONLY the pad provided by manufacturer.
- To reduce the risk of SIDS, pediatricians recommend healthy infants be placed on their backs to sleep, unless otherwise advised by your physician.
- If a sheet is used with the pad, use only the one provided by the bassinet or cradle manufacturer or one specifically designed to fit the dimension of the bassinet or cradle mattress.
- Keep the Habitat away from stairs, doors, windows, coffee tables, plants, lamps, TVs and wood stoves, fireplaces or heaters.
- Strings can cause strangulation! Do not place items with a string around a child's neck, such as hood strings or pacifier cords. Do not suspend strings over a bassinet or cradle or attach strings to toys.
- Keep curtain and blind cords out of the reach of babies and young children.
- Do not place this bassinet near a window or a patio door where a child could reach the cord of a blind or curtain and be strangled.
- Do not allow children to climb on or play with the Habitat.
- Never use plastic shipping bags or other plastic film as mattress covers not sold and intended for that purpose. They can cause suffocation.

Weight and height restrictions:

- Zipped (Bassinet position): 20 lbs max (9kg) and/or the child can roll over
- Unzipped (Playard position): 30 lbs max (13.5kg) and/or 35in (90cm) and/or the child is able to climb out

WARNINGS >>

(continued)

Please note the following to ensure safe use of your Playpen/Bassinet

- Do not use this product on any elevated surfaces such as tables, chairs, or counters.
- Fall Hazard: Child's activity may move Habitat. Use only on floor. Never use on any elevated surface.
- To avoid entrapment or pinching, do not disassemble or assemble when child is in or within reach of the Habitat.
- Only use accessories and replacement parts approved by guzzie+Guss
- Do not use this Product if there are any broken or missing parts.
- Check this bassinet regularly before using it and do not use it if any parts are loose or missing or if there are any signs of damage. Do not substitute parts. Contact the manufacturer if replacement parts or additional instructions are needed.
- Do not attach any accessories to the Habitat which have not been supplied by guzzie+Guss
- Discontinue use of the product when child is able to climb out or reaches the height of 35 in. (890 mm).
- Do not use this bassinet for a child who can roll over or who has reached the manufacturer's recommended weight limit.
- Child can become entrapped and die when improvised netting or covers are placed on top of product. Never add such items to confine child in product.
- When child is able to pull to standing position, set mattress/base to lowest adjustment position and remove bumper pads, large toys, and other objects that could serve as steps for climbing out.
- Use a bassinet mattress that is no thicker than 3.8 cm and is of such a size that, when it is pushed firmly against any side of the bassinet, it does not leave a gap of more than 3 cm between the mattress and any part of the sides of the bassinet.
- Children can suffocate on soft bedding. Do not place pillows, comforters or soft mattresses in this bassinet.
- Never place a child under the Bassinet
- You are responsible to provide adult supervision when using your bassinet