

## CARE & MAINTENANCE >>

1. ▲WARNING: Check the rivets, brakes and accessories very carefully before using this stroller.
2. ▲WARNING: Stop using this product if there is any damaged or broken parts or pieces.
3. Lubricate all moving parts and joints with a penetrating spray lubricant, from time to time.
4. Remove front and rear wheel housings and clean thoroughly from time to time.
5. Clean the stroller frame by wiping with moist cloth and dry thoroughly to prevent any rusting.
6. Always wipe dry your stroller after using it in the rain or in winter climates, making sure road salt is removed from frame and joints. Allow the stroller to stand in an open, warm and ventilated place to dry.
7. Do not leave your stroller outside in wet weather as the fabric will attract mildew.
8. Only hand-wash the fabric by using mild detergent in warm water. DO NOT wash in machine. Hang in a ventilated place to dry. DO NOT tumble dry.
9. It may be unsafe to use accessories other than those approved by the manufacturer or distributor.
10. It may be unsafe to use replacement parts other than those supplied or approved by the manufacturer or distributor.
11. If you have any questions regarding the product please contact guzzie + Guss at 1-888-597-0992, or online at [www.guzzieandguss.com](http://www.guzzieandguss.com).

## WARRANTY >>

The G+G 103 Pender has a Limited Warranty for the period of 1 year from the receipt of purchase against manufacturers' defects and workmanship.

For Warranty Registration:  
submit online @ [www.guzzieandguss.com](http://www.guzzieandguss.com)  
Or mail to the address provided below:

guzzie + Guss  
#114 - 6951 - 72nd street, Delta, BC  
Canada V4G 0A2

[info@guzzieandguss.com](mailto:info@guzzieandguss.com)  
North America: 1-888-597-0992  
Phone 1-604-940-9990  
Fax: 1-604-940-4462

G+G103 PENDER  
Instruction Manual

# guzzie+GUSS®

# Pender



Please read this instruction manual carefully before using this product.  
Be sure to save these instructions for future reference.

## INTRODUCTION >>

---

guzzie+Guss are committed to making the lives of children and parents safe uncomplicated and convenient. We would like to thank you for purchasing this exciting product. It is important that you read and follow the instructions in this manual carefully. Please make sure all the parts are properly attached and that removable pieces fit on correctly. Please pay close attention to the opening closing mechanism. Read all warnings and safety steps before use.

## IMPORTANT >>

---

After completely reading and following all instructions in this manual, please instruction manual in a safe place for future reference. If the product you have received operates differently from instructions included with the product please contact guzzie+Guss on the internet at [info@guzzieandguss.com](mailto:info@guzzieandguss.com). There you obtain the most current information regarding your new G+G 103 Pender stroller may have to provide the registration number and manufacturing date; this information will be found on frame of your stroller.

## INCLUDED PARTS >>

---

- 1) Stroller frame
- 2) Canopy
- 3) Front wheels (x2)
- 4) Shoulder Strap (attached to frame)
- 5) Car seat Safety strap
- 6) Instruction Manual

## WARNINGS >>

---

- Read and understand these instructions before using this product.
- Never leave child in the stroller unattended.
- To ensure proper use, store this user guide in a convenient place so it can be consulted often. Failure to follow all warnings and instructions could result in serious injury or death.
- **WARNING!** Care must be taken when folding and unfolding the product to prevent finger entrapment.
- This stroller is designed for one child.
- Make sure child's arms are clear when adjusting the seat – backrest up or down.
- Avoid serious injury from falling or sliding out. Always use the 5-point harness to secure child. Child may slip into leg openings and strangle.
- Never use in reclined carriage position(s) unless using the 5point harness
- Do not use stroller with a child who weighs more than 44 lbs (20kgs).
- Do not use stroller with a child taller than 44 inches (111.8 cm).
- Do not overload basket – Maximum weight in basket is 8 lbs (3.5kg). Overloading the basket may cause the stroller to become unstable.
- Always make certain that the stroller is fully open and locked before use.
- Assembly of this stroller must be performed only by an adult.
- Do not hang or place items on the stroller handle or frame except for those approved by guzzie+Guss. They may cause the stroller to become unstable.
- Do not allow children to climb on or play with the stroller.
- Never use stroller on stairs or escalators
- **WARNING.** Never allow the child to stand while in the stroller.
- To avoid entrapment or pinching, do not fold or unfold stroller when child is in or within reach of the stroller.
- Only use this stroller on even surfaces such as sidewalks and roads, and at walking speed.
- Stroller is intended for walking speed only. Do not use while jogging, skating, etc.
- Always set the parking brake when stroller is not moving.
- Only use accessories and replacement parts approved by guzzie+Guss
- Do not use this stroller if there are any broken or missing parts.
- When the stroller is not being used, please store the stroller in the dry and shady place.
- The stroller is not a toy; do not let children play with the stroller.

## ASSEMBLY >>

### Unfold the stroller chassis

1. With chassis lying on the floor with the handles pointed down, you will find on the right side of the chassis a lever. Lift the lever away from the side of the chassis and with your other hand lift up the handles.
2. Lift the stroller off the ground letting the front of the chassis fall away from the handles.
3. The chassis will begin to open. While holding onto the handles step on the black knob at the center of the back of the chassis. Pushing down with your foot will cause the chassis to completely open up and lock into the erect position.
4. Keep pushing until you hear an audible click.

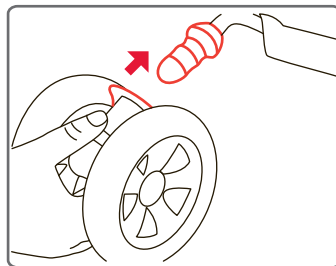
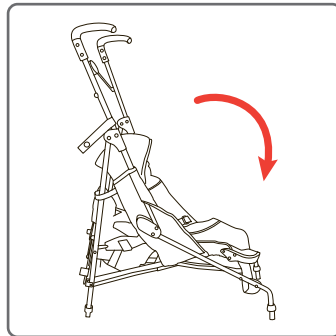
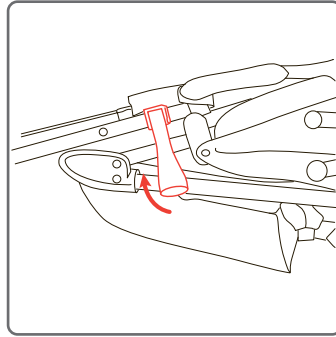

### Attach the front wheels

**NOTE:** You should lubricate the wheels prior to installing them. Use an oil based lubricant, and make sure to lubricate the shaft as well as the wheels on the axle.

1. Slide the front wheels into the front housings until they lock into place.
2. To remove the front wheel housing look for a release finger at the bottom of the wheel housing cylinder. While pinching the 2 tabs, slide the wheel housing cylinder off the post.

**ATTENTION:** make sure the wheels are properly attached by lightly tugging on the wheel.

### Attach the canopy

1. On both sides of the stroller chassis you will find a rectangular, grooved mount. Slide the canopy ratchet onto one of these side mounts (from the top to the bottom). Make sure to push enough to get the ratchet to be placed fully on the mount. (You will feel a positive click, when this has been completed) Repeat on the second side.
2. Just above the ratchet, on both sides of the stroller, you will find a flap of material, with Velcro on the inside, this will attach to the seat fabric.
3. On the back of the canopy flap, you will find 2 snap buttons, these coincide with 2 snap buttons on the back of the seat.
4. To remove the canopy: release the Velcro from the seat fabric and slide the ratchets up off the mounts. Then unsnap the 2 button snaps on the back of the seat.

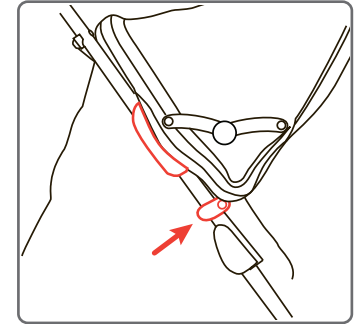

The Pender stroller has been equipped with a deluxe foldout visor on the front of the canopy; you can either pull this out, or tuck it back into the canopy to store it.

## USING YOUR STROLLER >>

### Folding the stroller

PLEASE NOTE: Always apply the brake before removing children from the stroller.

1. First release the stretcher bars on the sides of the canopy, and collapse the canopy against handles.
2. To fold the stroller, start by pushing up with your toe the black knob you stepped on to open the stroller. Once you have released the cross-brace with your toe, find the black foot lever on the right side half way up right rear leg of the stroller chassis. Step gently on the black foot lever while pushing the handles toward the front wheels.
3. Push forward on the handles until the handles lay against front wheels. The side closing lock will automatically engage.

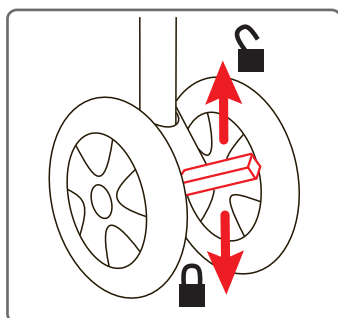
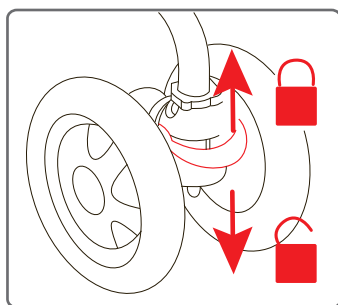
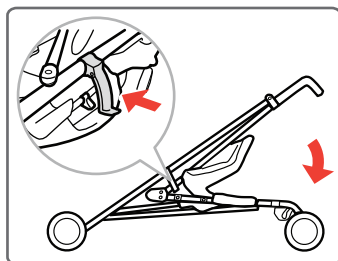
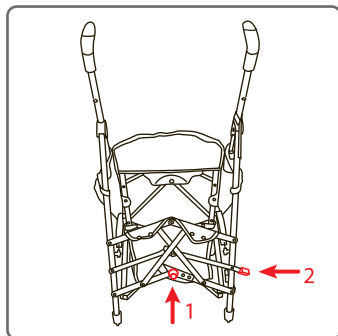

### Pushing the stroller

1. The front swiveling wheels can be locked into a stationary position (so they will not swivel). You will find on the top of both front wheel housings a black tongue lever. Lift up to engage the locking mechanism.
2. The rear wheels are equipped with a braking system which is attached to the rear wheel housing and exposed behind the wheels. Each wheel brake works independently of the other. To engage the brake, step on the black pedal behind each rear wheel. Always apply both wheel brakes.

### Reclining the seat

1. On both sides of the stroller, behind the backrest, you will find 2 release slides. Lifting up on both of the slide releases, will allow the seat to recline.
2. Make sure the seat is in the same position on both sides, otherwise the seat will be askew.
3. To erect the backrest simply lift up on the backrest stopping at the desired position.

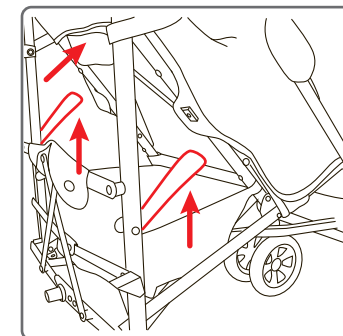

### Using the safety harness

Safety harness: The Pender stroller is equipped with a 5-point safety harness, which is to be used every time a child seated in the stroller. Both the waist strap and the 2 shoulder straps are adjustable to properly fit the child using the stroller. Insert the 2 waist strap tongues into center crotch strap buckle receiver, from right and left.

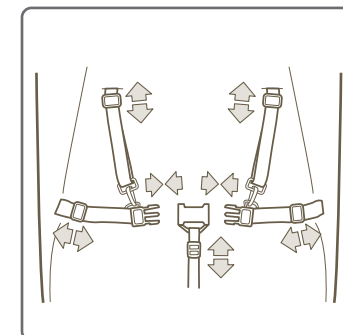

The shoulder harness is adjustable in height and can be changed by unthreading the shoulder strap from its current position and rethreading it through the shoulder belt positioning loop at the desired height. The length of the shoulder straps can also be changed by sliding the buckle on each shoulder strap.

**▲ WARNING:** Always fasten the 5-point harness securely and properly around the child's body whenever the child is seated in the stroller.

**▲ WARNING:** Never leave the child unattended when seated in the stroller

## Footrest

Find on both sides of the top of the foot rest where the leg bends, a button. When the buttons are pushed in the foot rest can be adjusted up or down to the desired position.

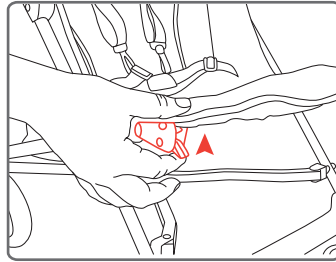

### Footrest Enclosure:

The Pender stroller is equipped with an enclosure for the front footrest. On both sides of the footrest you will find a flap attached to the ends of the footrest. Lift the footrest until the flap reaches to the side panel of the stroller seat. On the outside of the seat side panel you will find a Velcro strip where the flap is to be attached to. Using the footrest enclosure does not relieve the using of the 5 point harness system when the child is lying in the stroller.

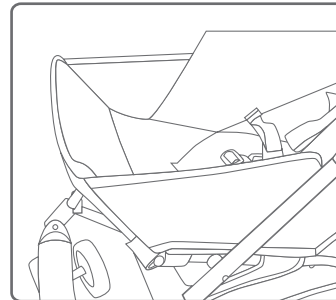

### Car Seat Compatibility:

The Pender has the ability to accept a car seat (some models may not work). First you need to attach both ends of the car seat safety strap to the 2 metal "D" rings located on both sides of the waist belts. Then you need to lift the footrest up to 90 degrees, and attach the footrest enclosure. Place your car seat facing the handles, and resting on the footrest. It should fit snugly between the frame of the stroller. Connect the car seat safety strap over the front of the seat, and connect the buckles. Make sure to feed the straps through your car seat's lap belt pathway. Tighten the straps until the straps are snug over the seat, and there is no movement in with your car seat.



**Warning:** make sure when using this feature the child is always strapped into your car seats

## OPTIONAL EQUIPMENT >>

### Universal Hitch

The universal hitch by guzzie+Guss hooks behind most strollers with its universal clips which allows you to stroller with a second child with ease.

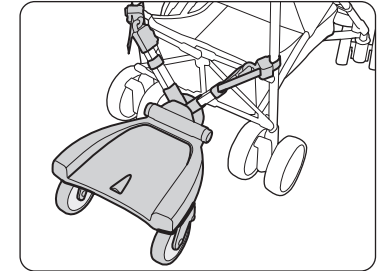

### Universal cup holder

The universal cup-holder by guzzie+Guss will allow you to take your favorite drink wherever you go and thanks to its universal attachment it will fit on all strollers.

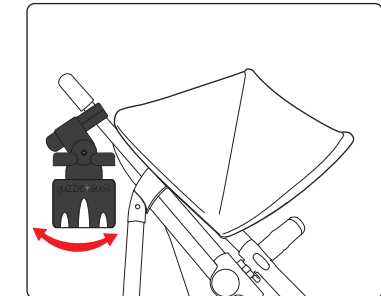

### Universal Rain Cover

Guzzie+Guss designed the Universal Umbrella stroller rain cover with parents in mind. The unique full zippered Front access window, allows parents to easily remove baby without having to remove the entire rain cover from the stroller.



## Limited Warranty >>

Your guzzie+Guss unit is warranted to be free from any manufacturing defects for a period of 1 year from the date of purchase under normal use and when used in compliance with the operating instructions. The warranty is non-transferable and is only valid for the original owner. This warranty is only effective when supplied with valid proof of purchase from an authorized guzzie+Guss retailer, please retain proof of purchase for the warranty.

The warranty is only valid in the original country of purchase. This warranty is subject to the conditions set forth by country in which it was purchased, conditions may vary. Guzzie+Guss will not ship replacement or repair part out of the country of original purchase.

Guzzie+Guss will conduct repairs or send out replacement parts as determined by guzzie+Guss or an authorized repair departments working on behalf of guzzie+Guss. Guzzie+Guss reserve the right to exchange a part or the item with a replacement part or unit. Some parts may be replaced with newer model parts as the unit may be improved over time.

Please note a service issue MAY NOT ALWAYS be covered by the warranty if:

- The issue is caused by misuse or poor maintenance. Please refer to your instructions for guidance on stroller use and maintenance.
- Damage is caused by improper installation of guzzie+Guss parts and or accessories.
- Damage is caused by corrosion caused by lack of maintenance.
- Damage is caused by general wear and tear, which is caused by everyday use.
- Damage is caused by sun intensity, sweat, detergents, damp storage or frequent washings.
- Repairs or modifications are carried out by third party
- Item are purchased from an unauthorized dealer.
- Item was purchase second hand
- Item was damaged as a result of an accident, airline or freight claim.

Guzzie+Guss reserves the right to determine if warranty terms and conditions have been met